

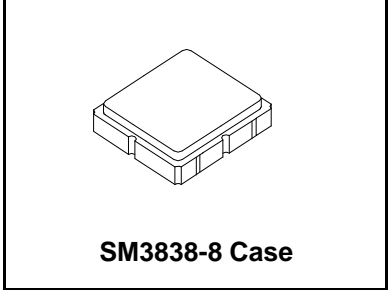

**SF1174D**

**374.00 MHz  
SAW Filter**



- **Designed for 802.11 Applications**
- **Hermetically sealed Surface Mount package**
- **Complies with Directive 2002/95/EC (RoHS)**



**Absolute Maximum Ratings**

Rating	Value	Units
Maximum Input Power	+10	dBm
DC Voltage Between Terminals	30	VDC
Case Temperature	-40 to +85	°C
Suitable for lead-free soldering - Max Soldering Profile	260°C for 30 s	

**Electrical Characteristics**

Characteristic	Sym	Notes	Minimum	Typical	Maximum	Units
Nominal Operating Frequency	$f_c$			374		MHz
Passband	Insertion Loss	IL		8.6	10	dB
			3.0 dB Bandwidth	17	23.3	MHz
Amplitude Ripple	$F_c \pm 7$ MHz			.6	1.0	dB
Group Delay Deviation	$F_c \pm 7$ MHz			45	100	nsec
Rejection	$F_c - 100$ to $-33$ MHz		40	47		dB
	$F_c - 33$ to $-22$ MHz		40	48		dB
	$F_c - 22$ to $-16.5$ MHz		27	40		dB
	$F_c + 16.5$ to $+22$ MHz		28	44		dB
	$F_c + 22$ to $+43$ MHz		35	44		dB
Ambient Temperature	Operating Range		-20		70	°C
Footprint Size: 3.8 X 3.8			SM3838-8			
Lid Symbolization (Y=Year, WW=week, S=shift)			479 // YWWS			

**Electrical Connections**

Connection	Terminals
Differential Input	2, 3
Differential Output	6, 7
Ground	All Others

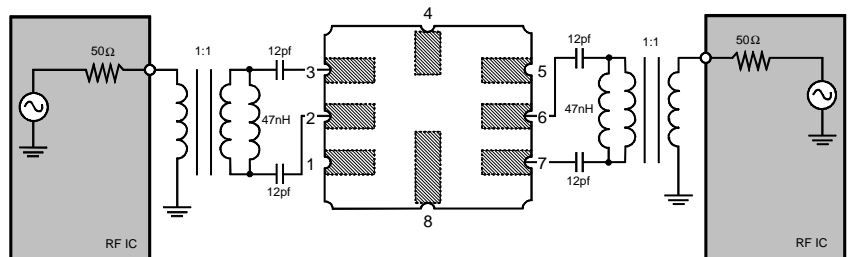

**CAUTION: Electrostatic Sensitive Device. Observe precautions for handling.**

**Notes:**

- 1.) All specifications apply over the operating temperature range with filter soldered to the specified demonstration board unless noted otherwise.
- 2.) Ultimate rejection is dependent on PCB layout.
- 3.) Specifications subject to change without notice.
- 4.) Electrostatic Sensitive Device. Observe precautions for handling.
- 5.) US and international patents may apply.
- 6.) RFM, RFM logo, and RF Monolithics, Inc. are registered trademarks of RF Monolithics, Inc.

## SF1174D-Demo Reference Plot

1dB per transformer insertion loss is not calibrated out

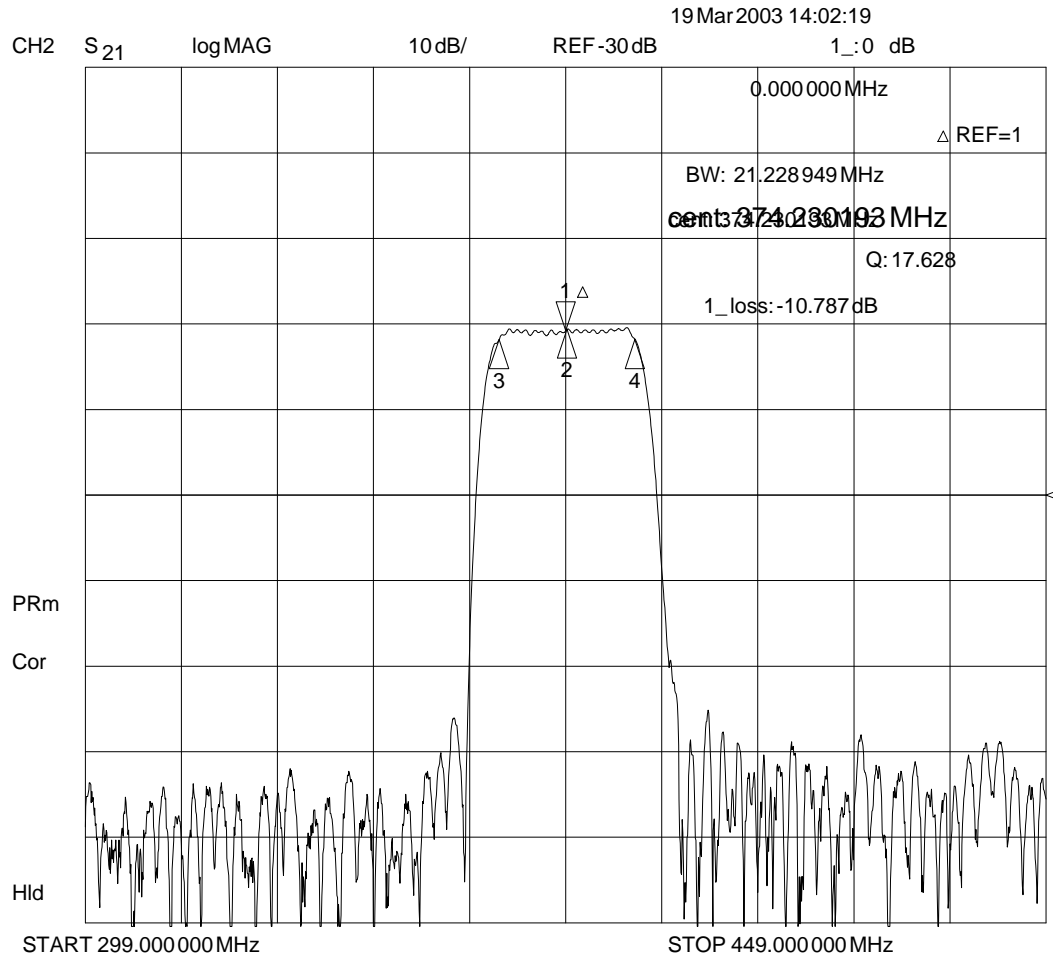

## SF1174D-Demo Reference Plot

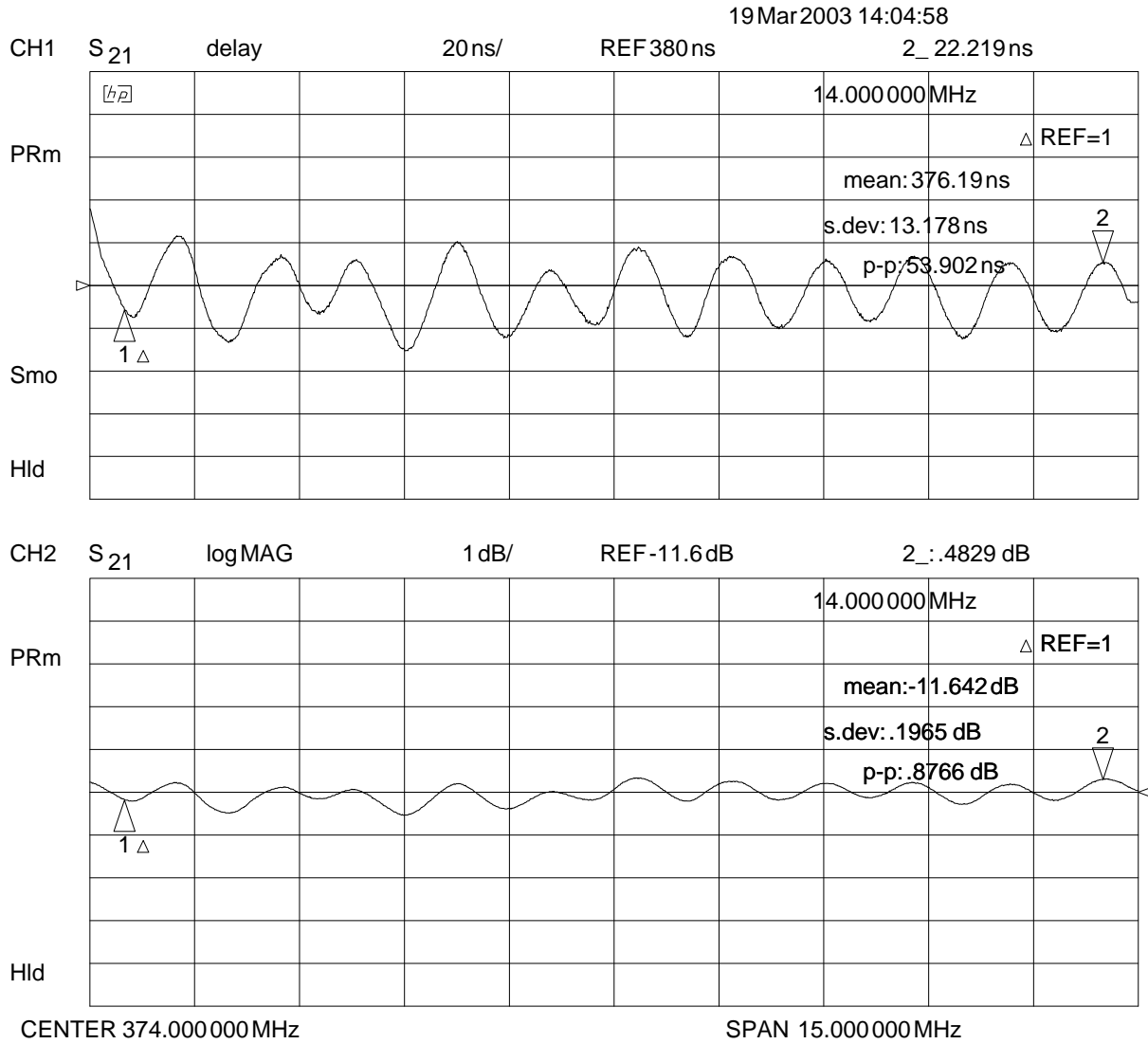

# SM3838-8 Case

## 8-Terminal Ceramic Surface-Mount Case 3.8 X 3.8 mm Nominal Footprint

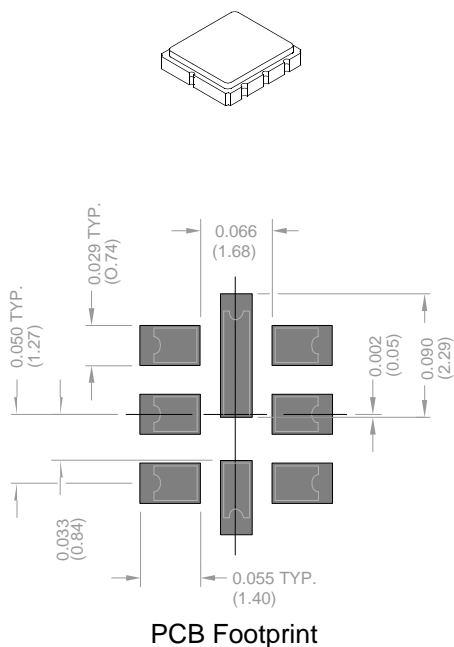

Case Dimensions						
Dimension	mm			Inches		
	Min	Nom	Max	Min	Nom	Max
A	3.6	3.8	4.0		0.15	
B	3.6	3.8	4.0		0.15	
C			1.25		0.06	
D		1.0			0.04	
E		1.0			0.04	
F		0.6			0.02	
G	2.39	2.54	2.69		0.100	
H		1.5			0.06	

Electrical Connections		
	Connection	Terminals
Port 1	Differential Input	2, 3
Port 2	Differential Output	6, 7
	Ground	All Others
<b>Single Ended Operation</b>		<b>Return is Ground</b>
<b>Differential Operation</b>		<b>Return is Hot</b>
Dot Indicates Pin 1		

Materials	
Solder Pad Termination	Au plating 30 - 60 ulnches (76.2-152 uM) over 80-200 ulnches (203-508 uM) Ni.
Lid	Fe-Ni-Co Alloy Electroless Nickel Plate (8-11% Phosphorus) 100-200 ulnches Thick
Body	Al <sub>2</sub> O <sub>3</sub> Ceramic
Pb Free	

TOP VIEW

BOTTOM VIEW

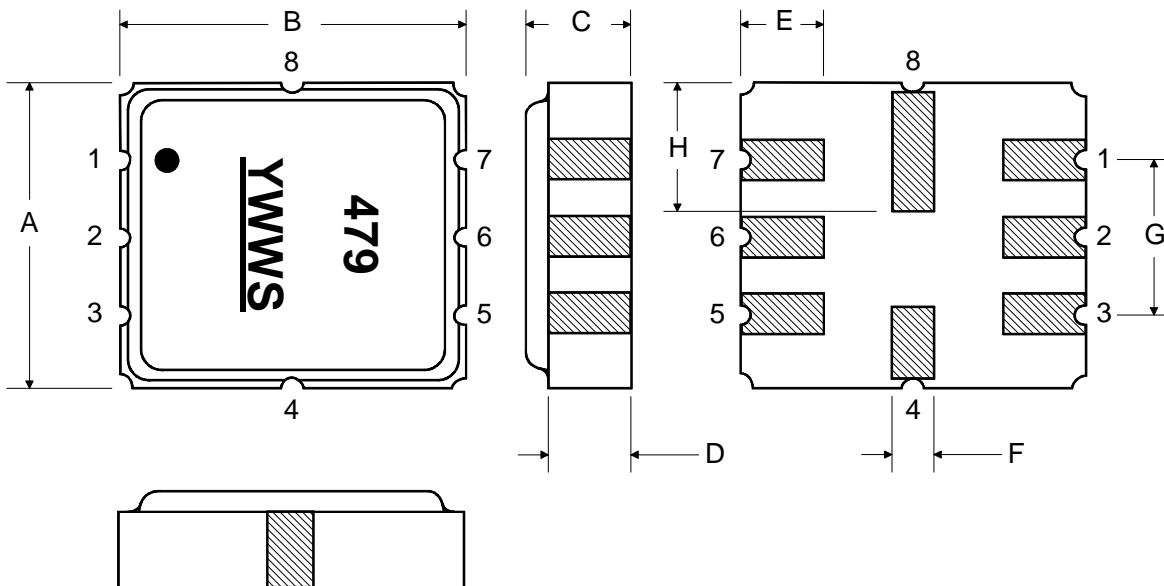

## Tape and Reel Specifications

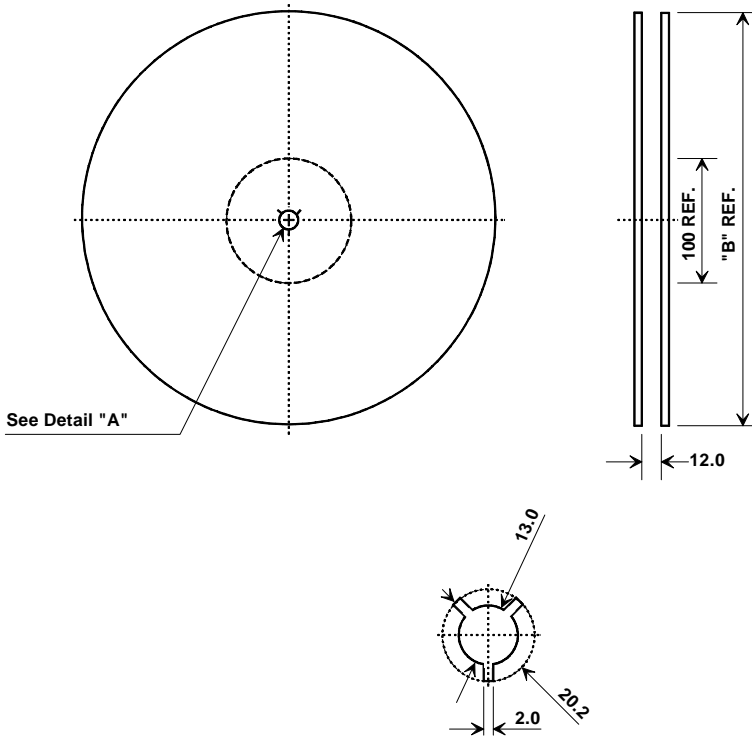

"B" Nominal Size		Quantity Per Reel
Inches	millimeters	
7	178	500
13	330	3000

## COMPONENT ORIENTATION and DIMENSIONS

Carrier Tape Dimensions	
<b>Ao</b>	4.25 mm
<b>Bo</b>	4.25 mm
<b>Ko</b>	1.30 mm
<b>Pitch</b>	8.0 mm
<b>W</b>	12.0 mm

